

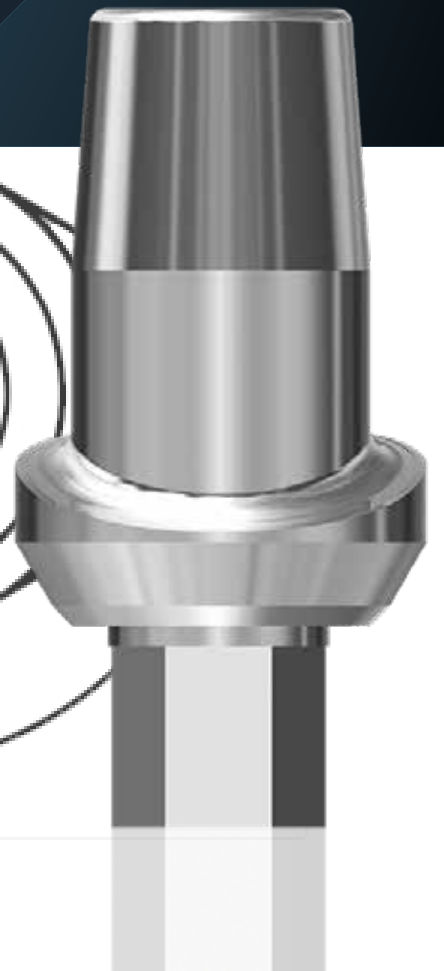

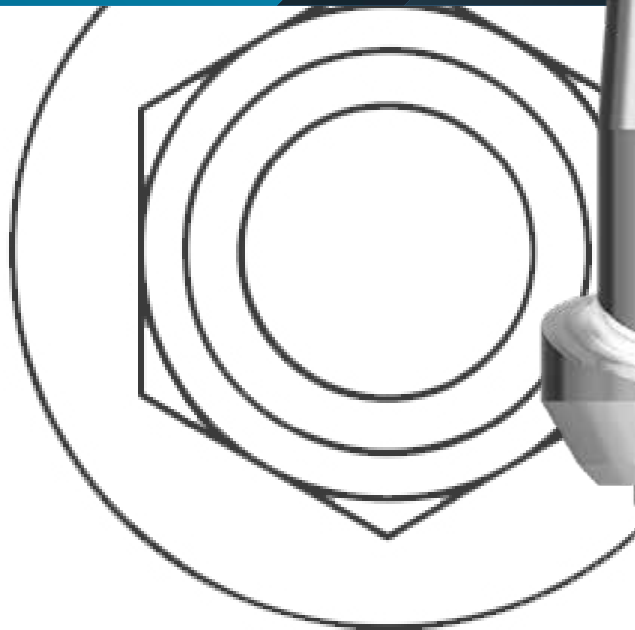





WX SERIE compatible
WINSIX®

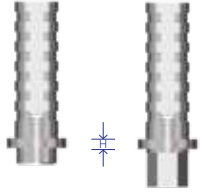

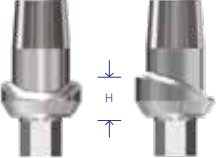
		Ø 3.3 ARTICOLO	Ø 3.8 ARTICOLO	Ø 4.5 ARTICOLO
	ANALOGO ANALOGO A - ACCIAIO	AN1091	AN1249	AN1335
	TRANSFER TRANSFER OPEN TRAY T15 - TITANIO GRADO 5	AN3079	AN3080	AN3081
	MONCONE PROVVISORIO ROTANTE - H 1.5 mm NON ROTANTE - H 1.5 mm T15 - TITANIO GRADO 5 PMMA - POLIMETILMETACRILATO	AN1227 AN2296	AN1231 AN2297	AN1233 AN1236
	MONCONE CALCINABILE ROTANTE NON ROTANTE PMMA - POLIMETILMETACRILATO	AN1986 AN2006	AN1987 AN2007	AN1988 AN2008
	MONCONE ESTETICO DRITTO H 2.0 mm T15 - TITANIO GRADO 5	AN1989	AN1990	AN2212
	MONCONE FRESABILE P.E. 4.5 P.E. 5.0 P.E. 6.0 T15 - TITANIO GRADO 5	AN2009 - -	- AN2010 -	- - AN2011
	MONCONE INCLINATO 15° H 2.0 mm T15 - TITANIO GRADO 5	AN2213	AN2214	AN2215
	VITE GUARIGIONE ANATOMICA ANATOMICA H 3.0 mm ANATOMICA H 5.0 mm DRITTA H 3.0 mm DRITTA H 5.0 mm T15 - TITANIO GRADO 5	- AN1078 AN1322 AN1340	AN1080 AN1081 AN1077 AN2400	AN1992 - AN1079 AN2401

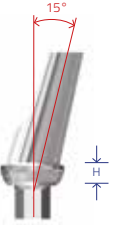
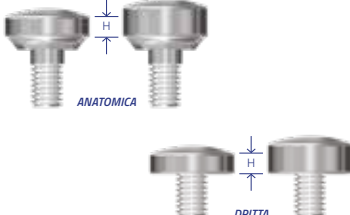

VITI

PROTESICA

T15 - TITANIO GRADO 5

Ø 3.3
ARTICOLO

AN1242

Ø 3.8
ARTICOLO

AN1242

Ø 4.5
ARTICOLO

AN1242

DUAL System

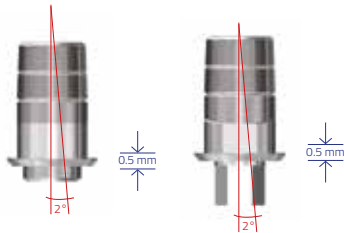

DUAL SYSTEM

ROTANTE - H 0.5 mm

NON ROTANTE - H 0.5 mm

T15 - TITANIO GRADO 5

Ø 3.3
ARTICOLO

AN1301

AN1108

Ø 3.8
ARTICOLO

AN1357

AN1111

Ø 4.5
ARTICOLO

AN1065

AN1115



SCANBODY

ROTANTE

NON ROTANTE

PEEK - POLI-ETER-ETER-CHETONE

SCAN N-R

SCAN N

SCAN R-R

SCAN R

SCAN R-R

SCAN R

Comby Chrome



COMBY CHROME

ROTANTE

NON ROTANTE

CR.CO - CROMO COBALTO

PMMA - POLIMETILMETACRILATO

Ø 3.3
ARTICOLO

AN2219

AN2216

Ø 3.8
ARTICOLO

AN2220

AN2217

Ø 4.5
ARTICOLO

AN2221

AN2218

	Ø 3.3	Ø 3.8	Ø 4.5
	N.cm 32	N.cm 32	N.cm 32
	M2.0	M2.0	M2.0
	Es 1.27 mm	Es 1.27 mm	Es 1.27 mm

NOTE LEGALI

Win Six® è un marchio registrato di BioSAF EUROPE

Tutti i marchi, i nomi e i codici registrati, appartengono ai legittimi proprietari e sono riportati unicamente per indicare la compatibilità con i nostri prodotti commerciali. Anteea S.r.l.