

D SERIE compatibile
STRAUMANN[®] / BONE LEVEL[®]

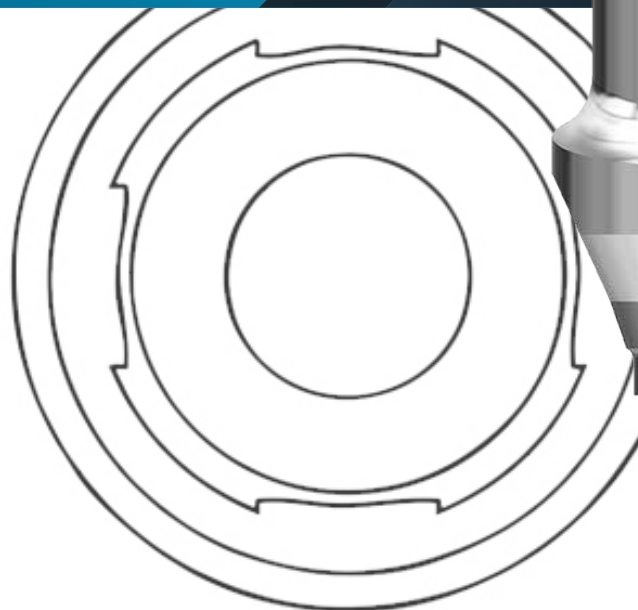



ANALOGO

ANALOGO

A - ACCIAIO

Ø 3.3 (NC)
ARTICOLO

AN1245

Ø 4.1/4.8 (RC)
ARTICOLO

AN1388



TRANSFER

OPEN TRAY

ROTANTE

T15 - TITANIO GRADO 5

AN1691

AN1692

AN2114

AN2115

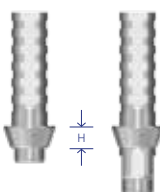

MONCONE PROVVISORIO

ROTANTE - H 1.5 mm

NON ROTANTE - H 1.5 mm

T15 - TITANIO GRADO 5

AN1154

AN1151

AN1153

AN1150



MONCONE CALCINABILE

ROTANTE

NON ROTANTE

PMMA - POLIMETILMETACRILATO

AN1576

AN1479

AN1577

AN1480

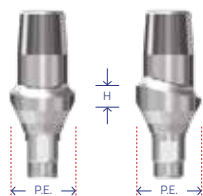

MONCONE ESTETICO DRITTO

H 2.0 mm - P.E. 4.0

H 2.0 mm - P.E. 5.0

H 3.5 mm - P.E. 4.0

H 3.5 mm - P.E. 5.0

T15 - TITANIO GRADO 5

AN1459

-

-

AN1461

AN1460

-

-

AN1462

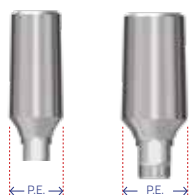

MONCONE DRITTO FRESABILE

P.E. 5.0

P.E. 6.0

T15 - TITANIO GRADO 5

AN1470

-

-

AN1471

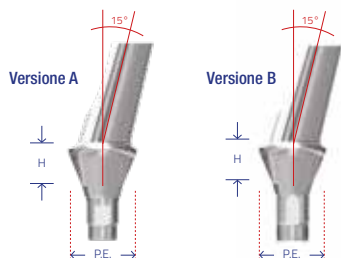

MONCONE INCLINATO 15°

H 3.5 mm - P.E. 4.0 versione "A"

H 3.5 mm - P.E. 4.0 versione "B"

H 3.5 mm - P.E. 5.0 versione "A"

H 3.5 mm - P.E. 5.0 versione "B"

T15 - TITANIO GRADO 5

AN1464

-

AN1535

-

-

AN1463

-

AN1466

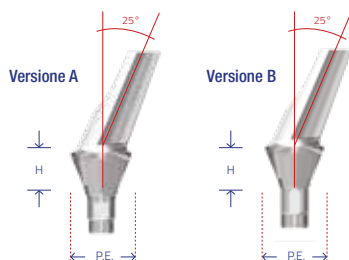

MONCONE INCLINATO 25°

H 3.5 mm - P.E. 4.0 versione "A"

H 3.5 mm - P.E. 4.0 versione "B"

H 3.5 mm - P.E. 5.0 versione "A"

H 3.5 mm - P.E. 5.0 versione "B"

T15 - TITANIO GRADO 5

AN1610

-

AN1611

-

-

AN1472

-

AN1481

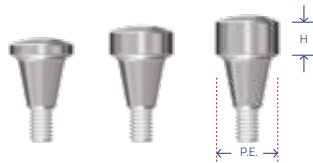

VITE GUARIGIONE ANATOMICA

- H 2.0 mm - P.E. 3.6
- H 2.0 mm - P.E. 4.5
- H 2.0 mm - P.E. 5.5
- H 4.0 mm - P.E. 3.6
- H 4.0 mm - P.E. 4.5
- H 4.0 mm - P.E. 5.5
- H 6.0 mm - P.E. 3.6
- H 6.0 mm - P.E. 4.5
- H 6.0 mm - P.E. 5.5

VITE COPERTURA IMPIANTO

T15 - TITANIO GRADO 5



VITI

- PROTESICA
- TRANSFER

T15 - TITANIO GRADO 5

Ø 3.3 (NC)
ARTICOLO

Ø 4.1/4.8 (RC)
ARTICOLO

AN1702	-
-	AN1704
-	AN2537
AN1706	-
-	AN1707
-	AN2538
AN1710	-
-	AN1711
-	AN2539
AN2524	AN2523

AN1239
AN1713

AN1239
AN1713

DUAL System

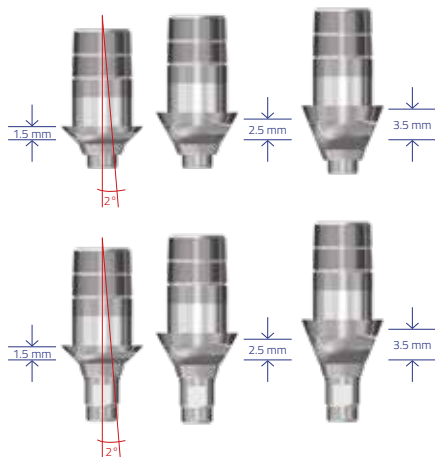

DUAL SISTEM

- ROTANTE - H 1.5 mm
- ROTANTE - H 2.5 mm
- ROTANTE - H 3.5 mm
- NON ROTANTE - H 1.5 mm
- NON ROTANTE - H 2.5 mm
- NON ROTANTE - H 3.5 mm

T15 - TITANIO GRADO 5

Ø 3.3 (NC)
ARTICOLO

Ø 4.1/4.8 (RC)
ARTICOLO

AN1976	AN1977
AN2821	AN2825
AN2822	AN2826
AN1106	AN1116
AN2823	AN2827
AN2824	AN2828

SCANBODY

- ROTANTE
- NON ROTANTE
- PEEK - POLI-ETER-ETER-CHETONE



SCAN N-R
SCAN N

SCAN N-R
SCAN N

Comby Chrome



COMBY CHROME

ROTANTE

NON ROTANTE

CR.CO - CROMO COBALTO

PMMA - POLIMETILMETACRILATO



VEDI SOLUZIONI OVERDENTURE PAG 120

MONCONE CONNEKTOR

H 1.0 mm

H 2.0 mm

H 3.0 mm

H 4.0 mm

H 5.0 mm

T15 - TITANIO GRADO 5

Ø 3.3 (NC)
ARTICOLO

Ø 4.1/4.8 (RC)
ARTICOLO

AN1698

AN1700

AN1697

AN1699

AN2833

AN2838

AN2834

AN2839

AN2835

AN2840

AN2836

AN2841

AN2837

AN2842

KIT 1081 - SET LAVORAZIONE 0°-10°

1 CUFFIA NERA, 1 SPAZIATORI BIANCHI, 1 CUFFIA TRASPARENTE, 1 CUFFIA ROSA, 1 CUFFIA BLUE, 1 CONTENITORE IN TITANIO.



KIT 1082 - SET LAVORAZIONE 10°-20°

1 CUFFIA NERA, 1 SPAZIATORI BIANCHI, 1 CUFFIA VERDE, 1 CUFFIA ROSSA, 1 CUFFIA ARANCIO, 1 CONTENITORE IN TITANIO.



COMPONENTISTICA PER PROTESI AVVITATA

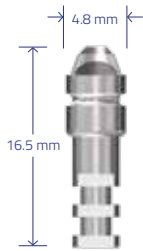

ANALOGO MULTI-BASE

ANALOGO MULTI-BASE

AN1297

A - ACCIAIO

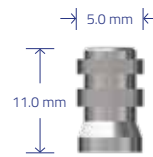

TRANSFER MULTI-BASE

TRANSFER MULTI-BASE

AN1690

T15 - TITANIO GRADO 5

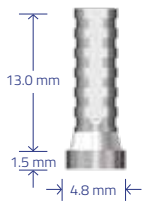

MONCONE PROVVISORIO MULTI-BASE

PROVVISORIO MULTI-BASE

AN1066

T15 - TITANIO GRADO 5



MONCONE CALCINABILE MULTI-BASE

CALCINABILE MULTI-BASE

AN1524

PMMA - POLIMETILMETACRILATO



DUAL Sistem[®] DUAL SISTEM MULTI-BASE

DUAL SISTEM M.U.A.

AN1330

T15 - TITANIO GRADO 5

PMMA - POLIMETILMETACRILATO



Comby Chrome

COMBY CHROME MULTI-BASE

COMBY CHROME M.U.A.

AN1341

CR.CO - CROMO COBALTO

PMMA - POLIMETILMETACRILATO

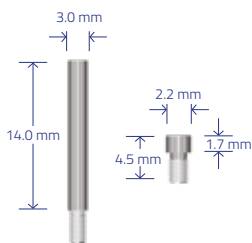

VITI MULTI-BASE

MICROVITE MULTI-BASE

AN1247

TRANSFER MULTI-BASE

AN1254

T15 - TITANIO GRADO 5

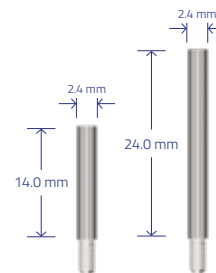

VITE CERATURA MULTI-BASE

SHORT

AN2781

LONG

AN2782

T15 - TITANIO GRADO 5



SCANBODY MULTI-BASE

SCANBODY MULTI-BASE SCAN-M-D

AEM - ALLUMINIO ERGAL MEDICALE



VITE PROTEZIONE MULTI-BASE

H 4.0 mm

AN1708

T15 - TITANIO GRADO 5

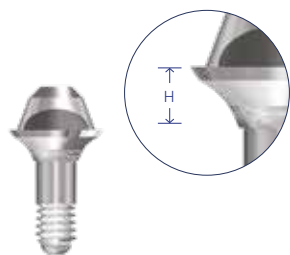

MULTI-BASE DRITTO

H 1.0 mm

H 2.5 mm

H 4.0 mm

Ti5 - TITANIO GRADO 5

Ø 3.3 (NC)
ARTICOLO

AN1287

AN1701

AN1693

Ø 4.1/4.8 (RC)
ARTICOLO

AN1293

AN1703

AN1695

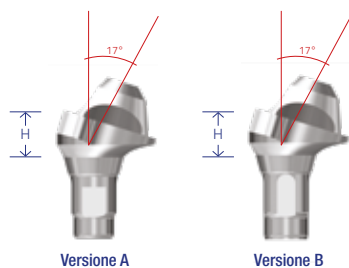

MULTI-BASE INCLINATO 17°

H 2.5 mm - Versione "A"

H 2.5 mm - Versione "B"

H 4.0 mm - Versione "A"

H 4.0 mm - Versione "B"

Ti5 - TITANIO GRADO 5

AN1182

AN1183

AN1184

AN1185

AN1714

AN1715

AN1716

AN1717

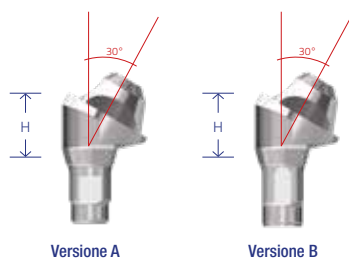

MULTI-BASE INCLINATO 30°

H 3.5 mm - Versione "A"

H 3.5 mm - Versione "B"

H 4.5 mm - Versione "A"

H 4.5 mm - Versione "B"

Ti5 - TITANIO GRADO 5

AN1718

AN1719

AN1299

AN1300

AN1289

AN1290

AN1291

AN1292



VITI MULTI-BASE

VITE MULTI-BASE ANGOLATO

Ti5 - TITANIO GRADO 5

AN1689

AN1689

	Ø 3.3 (NC)	Ø 4.1/4.8 (RC)	MULTI-BASE
	N.cm 25	N.cm 25	N.cm 15
	M1.6	M1.6	M1.4
	TORK 6	TORK 6	TORK 6

NOTE LEGALI

ITI®, Straumann®, Bone Level® marchi registrati da Straumann Holding AG, Svizzera.

Tutti i marchi, i nomi e i codici registrati, appartengono ai legittimi proprietari e sono riportati unicamente per indicare la compatibilità con i nostri prodotti commerciali. Anteea S.r.l.