

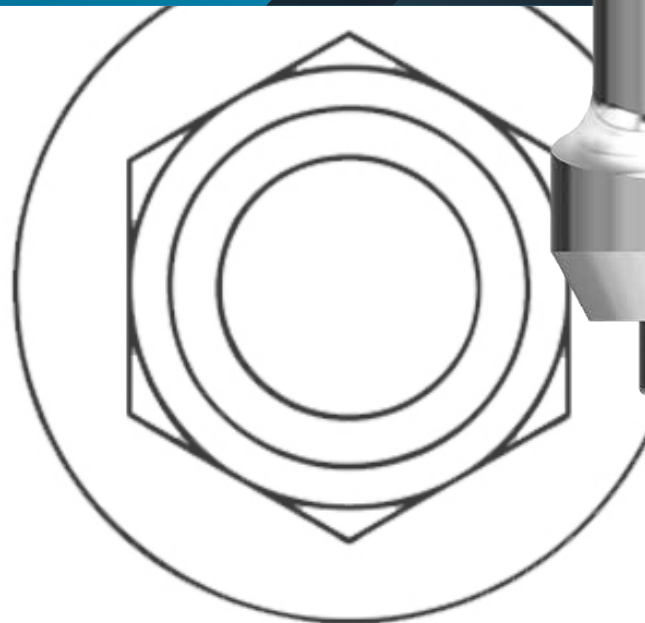

FX SERIE compatible
DENTSPLY® / XIVE®





ANALOGO

ANALOGO

A - ACCIAIO

Ø 3.4
ARTICOLO

AN1802

Ø 3.8
ARTICOLO

AN2032

Ø 4.5
ARTICOLO

AN2033



TRANSFER

TRANSFER OPEN TRAY

T15 - TITANIO GRADO 5

AN2361

AN2362

AN1014

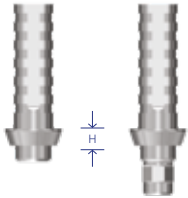

MONCONE PROVVISORIO

ROTANTE - H 1.5 mm

NON ROTANTE - H 1.5 mm

T15 - TITANIO GRADO 5

AN2363

AN2364

AN1059

AN1060

AN1061

AN1063



MONCONE CALCINABILE

ROTANTE

NON ROTANTE

PMMA - POLIMETILMETACRILATO

AN1052

AN1053

AN1064

AN2014

AN2013

AN2012

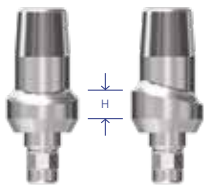

MONCONE ESTETICO DRITTO

H 2.0 mm

H 4.0 mm

T15 - TITANIO GRADO 5

AN1513

AN1514

AN1522

AN1523

AN1525

AN1526



MONCONE FRESABILE

MONCONI FRESABILI

T15 - TITANIO GRADO 5

AN2015

AN2016

AN2017

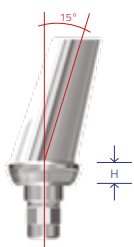

MONCONE INCLINATO 15°

H 2.0 mm

H 4.0 mm

T15 - TITANIO GRADO 5

AN1517

AN1515

AN1520

AN1518

AN1516

AN1521



VITI

PROTESICA

TRANSFER

Ti5 - TITANIO GRADO 5



VITE GUARIGIONE ANATOMICA

H 2.0 mm

H 3.0 mm

H 5.0 mm

Ti5 - TITANIO GRADO 5

Ø 3.4
ARTICOLO

Ø 3.8
ARTICOLO

Ø 4.5
ARTICOLO

AN1351

AN1351

AN1351

AN1327

AN1327

AN1327

AN2298

AN2301

AN2304

AN2299

AN2302

AN2305

AN2300

AN2303

AN2306

DUAL System

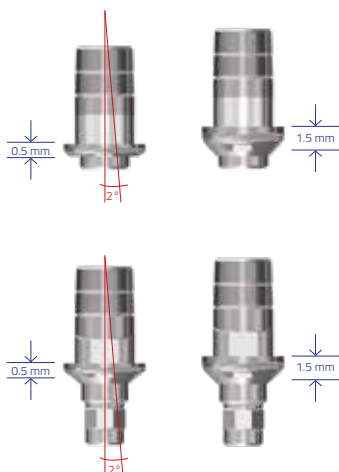

DUAL SYSTEM

ROTANTE - H 0.5 mm

ROTANTE - H 1.5 mm

NON ROTANTE - H 0.5 mm

NON ROTANTE - H 1.5 mm

Ti5 - TITANIO GRADO 5

Ø 3.4
ARTICOLO

Ø 3.8
ARTICOLO

Ø 4.5
ARTICOLO

AN1968

AN1969

AN1970

AN2846

AN2847

AN2848

AN1432

AN1433

AN1434

AN2843

AN2844

AN2845



SCANBODY

ROTANTE

NON ROTANTE

PEEK - POLI-ETER-ETER-CHETONE

SCAN N-R

SCAN N-R

SCAN R-R

SCAN N

SCAN N

SCAN R

Comby Chrome



COMBY CHROME

ROTANTE

NON ROTANTE

T15 - TITANIO GRADO 5
PMMA - POLIMETILMETACRILATO

Ø 3.4
ARTICOLO

Ø 3.8
ARTICOLO

Ø 4.5
ARTICOLO

AN1630

AN1240

AN1971

AN1435

AN2153

AN2154

FOR PRESS



BASE "FOR PRESS"

ROTANTE

NON ROTANTE

T15 - TITANIO GRADO 5

AN2849

-

AN2851

AN2852

-

AN2854



MONCONE CONNEKTOR

H 1.0 mm

H 2.0 mm

H 3.0 mm

H 4.0 mm

H 5.0 mm

T15 - TITANIO GRADO 5

AN2855

AN2860

AN2865

AN2856

AN2861

AN2866

AN2857

AN2862

AN2867

AN2858

AN2863

AN2868

AN2859

AN2864

AN2869

VEDI SOLUZIONI OVERDENTURE PAG 120

KIT 1081 - SET LAVORAZIONE 0°-10°

1 CUFFIA NERA, 1 SPAZIATORI BIANCHI, 1 CUFFIA TRASPARENTE, 1 CUFFIA ROSA, 1 CUFFIA BLUE, 1 CONTENITORE IN TITANIO.



KIT 1082 - SET LAVORAZIONE 10°-20°

1 CUFFIA NERA, 1 SPAZIATORI BIANCHI, 1 CUFFIA VERDE, 1 CUFFIA ROSSA, 1 CUFFIA ARANCIO, 1 CONTENITORE IN TITANIO.



COMPONENTISTICA PER PROTESI AVVITATA

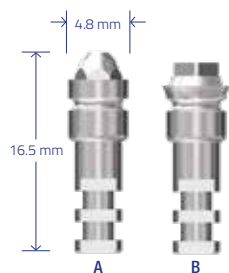

ANALOGO M.U.A.

A. ANALOGO M.U.A. AN1604

B. M.P. Ø 3.4/3.8 AN1487

B. MP Ø 4.5 AN1488

A - ACCIAIO

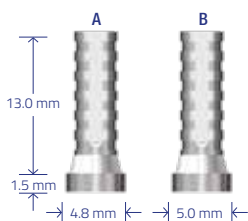

MONCONE PROVVISORIO M.U.A.

A. PROVVISORIO M.U.A. AN1226

B. M.P. Ø 3.4/3.8 AN1361

B. MP Ø 4.5 AN1352

Ti5 - TITANIO GRADO 5

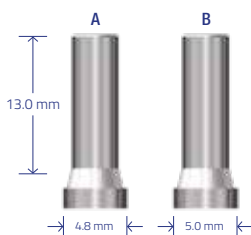

MONCONE M.U.A. SALDATURA

A. MONCONE M.U.A. SALD. AN2777

B. M.P. Ø 3.4/3.8 AN1001

B. MP Ø 4.5 AN1002

Ti5 - TITANIO GRADO 5



TRANSFER M.U.A.

TRANSFER M.U.A.

AN2098

Ti5 - TITANIO GRADO 5

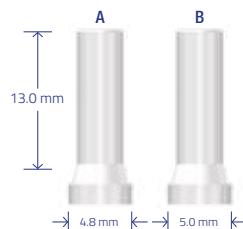

MONCONE CALCICIBILE M.U.A.

A. CALCICIBILE M.U.A. AN2099

B. CALCICIBILE M.P. AN1045

PMMA - POLIMETILMETACRILATO



ANALOGO PROTEZIONE M.U.A.

H 4.0 MM

AN2275

Ti5 - TITANIO GRADO 5



Comby Chrome

COMBY CHROME M.U.A.

COMBY CHROME M.U.A.

AN1157

CR.CO - CROMO COBALTO

PMMA - POLIMETILMETACRILATO



DUAL Sistem

DUAL SYSTEM M.U.A.

DUAL SYSTEM M.U.A.

AN1156

Ti5 - TITANIO GRADO 5

PMMA - POLIMETILMETACRILATO

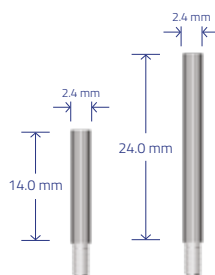

VITE CERATURA M.U.A.

SHORT

AN1663

LONG

AN2778

Ti5 - TITANIO GRADO 5

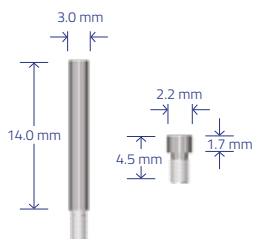

VITI M.U.A.

MICROVITE M.U.A. AN1360

TRANSFER M.U.A. AN1663

MICROVITE M.P. AN1348

TRANSFER M.P. AN1241

Ti5 - TITANIO GRADO 5



VITE PROTEZIONE M.U.A.

H 4.0 mm

AN2267

Ti5 - TITANIO GRADO 5



SCANBODY M.U.A.

SCANBODY M.U.A. SCAN-M-FX

SCANBODY M.P. SCAN-M-P

AEM - ALLUMINIO ERGAL MEDICALE

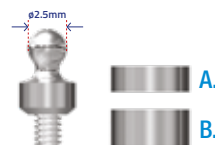

MONCONE SFERA TG/MP

A. H 3.0 mm AN1100

B. H 5.0 mm AN2036

Ti5 - TITANIO GRADO 5

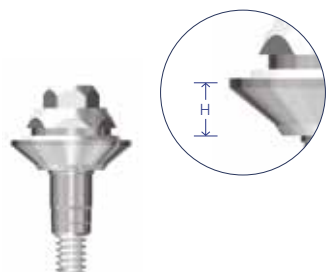

MONCONE M.U.A. DRITTO

H 1.0 mm

H 2.0 mm

H 3.0 mm

H 5.0 mm

Ti5 - TITANIO GRADO 5

Ø 3.4
ARTICOLO

Ø 3.8
ARTICOLO

Ø 4.5
ARTICOLO

AN2034

AN2035

AN2203

AN2204

AN2205

AN2206

AN2207



AN2208

AN2209

AN2210

AN2211

-

	Ø 3.4	Ø 3.8	Ø 4.5	MP	M.U.A.
	N.cm 25	N.cm 25	N.cm 25	N.cm 25	N.cm 15
	M1.6	M1.6	M1.6	M1.6	M1.4
	Es 2.2 mm	Es 2.5 mm	Es 2.5 mm	-	-

CHIAVI INSERIMENTO M.U.A.

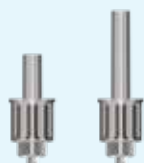

M.U.A. DRIVER FOR RATCHET

LONG ST1106

SHORT ST1107

A - ACCIAIO



M.U.A. DRIVER

M.U.A. DRIVER ST1001

A - ACCIAIO

SERRAGGIO

Il serraggio della vite protesica va effettuato con cricchetto dinamometrico e chiave protesica 1,27. Vengono raccomandati torques di 25 Ncm. Per il serraggio della microvite si raccomanda di non superare i 15 Ncm.

NOTE LEGALI

Ankylos®, Frialit® and XIVE® sono un marchi registrati da Dentsply® International Inc., USA.

Tutti i marchi, i nomi e i codici registrati, appartengono ai legittimi proprietari e sono riportati unicamente per indicare la compatibilità con i nostri prodotti commerciali. Anteea S.r.l.